



**HDPE Pipes & Fittings**



Ống HDPE có những đặc tính quý báu và ưu việt hơn hẳn các ống nhựa khác.

- Ống nhựa HDPE rất bền, chịu được rất tốt với những chất lỏng và dung dịch thường gặp trên đường dẫn và đất thoát nước. Nó không bị rỉ, không bị tác dụng bởi các dung dịch muối, axit và kiềm, kể cả nước mưa axit cũng không ảnh hưởng tới loại ống này.

- Sự chịu đựng đối với ánh sáng mặt trời và nhiệt độ của ống HDPE rất tốt, nó không bị lão hóa về cơ lý hóa khi ống HDPE bị để lâu ngày dưới tia cực tím của mặt trời.

- Ống HDPE có đặc tính chịu uốn lệch rất tốt và có sức chịu biến dạng cao.

*Quality Star Award  
PARIS - FRANCE 2006*

Sản phẩm của  **SINO**<sup>®</sup>



# Ống nước HDPE và phụ kiện

## HDPE Pipes & Fittings

### HDPE Pipes & Fittings

#### HDPE - PE80 HDPE - PE100

Ống HDPE (sọc xanh)  
Tiêu chuẩn 4427:2007 (E); TCVN 7305: 2008  
Có đường kính từ Ø16mm - Ø500mm với  
nguyên liệu chính PE80 và PE100 cung cấp cho  
các công trình sử dụng làm hệ thống cấp nước.



**Nối góc**  
Equal Elbow



**Nối góc ren trong**  
Female Elbow



**Nối góc ren ngoài**  
Male Elbow



**Tê đều**  
Equal Tee



**Tê ren trong**  
Female Tee



**Tê ren ngoài**  
Male Tee



**Tê chuyển bậc**  
Reducing Tee



**Nối thẳng**  
Equal Coupling



**Nối thẳng chuyển bậc**  
Reducing Coupling



**Đầu nối ren trong**  
Female Adaptor



**Đầu nối ren ngoài**  
Male Adaptor



**Đầu bịt**  
End Cap

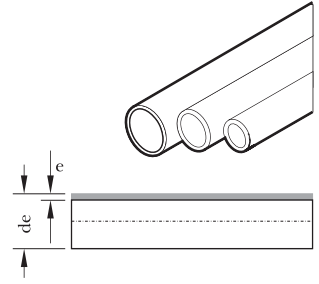

**Đai khởi thủy**  
Tapping Saddle

**Ống nước HDPE PE80 (Độ dài: 6m)**  
 HDPE PE80 Pipe (Length: 6m)

**Ống nước HDPE PN6 - HDPE PN6 Pipes**

Mã số Code	de	e	Đơn giá Unit Price (VND/1m)
PD/16PN6	16	0.8	4.000
PD/20PN6	20	1.0	5.600
PD/25PN6	25	1.2	8.000
PD/32PN6	32	1.6	13.200
PD/40PN6	40	2.0	18.200
PD/50PN6	50	2.4	28.500
PD/63PN6	63	3.0	43.800
PD/75PN6	75	3.6	62.500
PD/90PN6	90	4.3	100.000
PD/110PN6	110	5.3	132.000
PD/125PN6	125	6.0	171.000
PD/140PN6	140	6.7	212.000
PD/160PN6	160	7.7	279.000

Mã số Code	de	e	Đơn giá Unit Price (VND/1m)
PD/180PN6	180	8.6	351.000
PD/200PN6	200	9.6	435.000
PD/225PN6	225	10.8	549.000
PD/250PN6	250	11.9	672.000
PD/280PN6	280	13.4	845.000
PD/315PN6	315	15.0	1.062.000
PD/355PN6	355	16.9	1.359.000
PD/400PN6	400	19.1	1.713.000
PD/450PN6	450	21.5	2.186.000
PD/500PN6	500	23.9	2.670.000
PD/630PN6	630	30.0	4.630.000
PD/800PN6	800	38.1	7.486.000

**Ống nước HDPE PN8 - HDPE PN8 Pipes**

Mã số Code	de	e	Đơn giá Unit Price (VND/1m)
PD/16PN8	16	1.0	4.800
PD/20PN8	20	1.2	6.600
PD/25PN8	25	1.5	9.800
PD/32PN8	32	2.0	14.800
PD/40PN8	40	2.4	22.200
PD/50PN8	50	3.0	34.500
PD/63PN8	63	3.8	54.800
PD/75PN8	75	4.5	77.500
PD/90PN8	90	5.4	112.000
PD/110PN8	110	6.6	163.000
PD/125PN8	125	7.4	208.000
PD/140PN8	140	8.3	261.000
PD/160PN8	160	9.5	341.000

Mã số Code	de	e	Đơn giá Unit Price (VND/1m)
PD/180PN8	180	10.7	432.000
PD/200PN8	200	11.9	537.000
PD/225PN8	225	13.4	678.000
PD/250PN8	250	14.8	833.000
PD/280PN8	280	16.6	1.046.000
PD/315PN8	315	18.7	1.324.000
PD/355PN8	355	21.1	1.669.000
PD/400PN8	400	23.7	2.131.000
PD/450PN8	450	26.7	2.677.000
PD/500PN8	500	29.7	3.328.000
PD/630PN8	630	37.4	5.700.000
PD/800PN8	800	47.4	9.185.000

**Ống nước HDPE PN10 - HDPE PN10 Pipes**

Mã số Code	de	e	Đơn giá Unit Price (VND/1m)
PD/16PN10	16	1.2	5.000
PD/20PN10	20	1.5	7.500
PD/25PN10	25	2.0	10.800
PD/32PN10	32	2.4	17.200
PD/40PN10	40	3.0	26.800
PD/50PN10	50	3.7	41.200
PD/63PN10	63	4.7	65.600
PD/75PN10	75	5.6	93.800
PD/90PN10	90	6.7	133.000
PD/110PN10	110	8.1	201.000
PD/125PN10	125	9.2	256.000
PD/140PN10	140	10.3	320.000
PD/160PN10	160	11.8	419.000

Mã số Code	de	e	Đơn giá Unit Price (VND/1m)
PD/180PN10	180	13.3	530.000
PD/200PN10	200	14.7	659.000
PD/225PN10	225	16.6	815.000
PD/250PN10	250	18.4	1.007.000
PD/280PN10	280	20.6	1.263.000
PD/315PN10	315	23.2	1.598.000
PD/355PN10	355	26.1	2.029.000
PD/400PN10	400	29.4	2.580.000
PD/450PN10	450	33.1	3.263.000
PD/500PN10	500	36.8	4.048.000
PD/630PN10	630	46.3	6.941.000
PD/800PN10	800	48.8	9.435.000

**Ống nước HDPE PN12.5 - HDPE PN12.5 Pipes**

Mã số Code	de	e	Đơn giá Unit Price (VND/1m)
PD/16PN12.5	16	1.5	5.380
PD/20PN12.5	20	2.0	8.200
PD/25PN12.5	25	2.3	12.600
PD/32PN12.5	32	3.0	20.800
PD/40PN12.5	40	3.7	32.200
PD/50PN12.5	50	4.6	49.800
PD/63PN12.5	63	5.8	79.000
PD/75PN12.5	75	6.8	110.000
PD/90PN12.5	90	8.2	159.000
PD/110PN12.5	110	10.0	238.000
PD/125PN12.5	125	11.4	310.000
PD/140PN12.5	140	12.7	382.000
PD/160PN12.5	160	14.6	502.000

Mã số Code	de	e	Đơn giá Unit Price (VND/1m)
PD/180PN12.5	180	16.4	637.000
PD/200PN12.5	200	18.2	786.000
PD/225PN12.5	225	20.5	983.000
PD/250PN12.5	250	22.7	1.229.000
PD/280PN12.5	280	25.4	1.540.000
PD/315PN12.5	315	28.6	1.925.000
PD/355PN12.5	355	32.2	2.442.000
PD/400PN12.5	400	36.3	3.099.000
PD/450PN12.5	450	40.9	3.912.000
PD/500PN12.5	500	45.4	4.868.000
PD/630PN12.5	630	57.2	7.880.000
PD/800PN12.5	800	72.6	13.560.000

**Ống nước HDPE PN16 - HDPE PN16 Pipes**

Mã số Code	de	e	Đơn giá Unit Price (VND/1m)
PD/16PN16	16	2.0	7.600
PD/20PN16	20	2.3	10.000
PD/25PN16	25	3.0	15.200
PD/32PN16	32	3.6	25.000
PD/40PN16	40	4.5	38.200
PD/50PN16	50	5.6	58.800
PD/63PN16	63	7.1	93.800
PD/75PN16	75	8.4	133.000
PD/90PN16	90	10.1	191.000
PD/110PN16	110	12.3	289.000
PD/125PN16	125	14.0	370.000
PD/140PN16	140	15.7	463.000

Mã số Code	de	e	Đơn giá Unit Price (VND/1m)
PD/160PN16	160	17.9	607.000
PD/180PN16	180	20.1	767.000
PD/200PN16	200	22.4	954.000
PD/225PN16	225	25.2	1.180.000
PD/250PN16	250	27.9	1.458.000
PD/280PN16	280	31.3	1.827.000
PD/315PN16	315	35.2	2.324.000
PD/355PN16	355	39.7	2.950.000
PD/400PN16	400	44.7	3.753.000
PD/450PN16	450	50.3	4.892.000
PD/500PN16	500	55.8	6.062.000

**Ống nước HDPE PE100**

HDPE PE100 Pipe

**Ống nước HDPE PN6 - HDPE PN6 Pipes**

Mã số Code	de	e	Đơn giá Unit Price (VND/1m)
PF/20PN6	20	0.8	3.800
PF/25PN6	25	1.0	6.000
PF/32PN6	32	1.3	9.600
PF/40PN6	40	1.6	17.600
PF/50PN6	50	2.0	24.200
PF/63PN6	63	2.5	37.200
PF/75PN6	75	2.9	51.200
PF/90PN6	90	3.5	72.800
PF/110PN6	110	4.2	108.000
PF/125PN6	125	4.8	138.000
PF/140PN6	140	5.4	174.000
PF/160PN6	160	6.2	231.000
PF/180PN6	180	6.9	284.000

Mã số Code	de	e	Đơn giá Unit Price (VND/1m)
PF/200PN6	200	7.7	354.000
PF/225PN6	225	8.6	444.000
PF/250PN6	250	9.6	548.000
PF/280PN6	280	10.7	680.000
PF/315PN6	315	12.1	868.000
PF/355PN6	355	13.6	1.102.000
PF/400PN6	400	15.3	1.392.000
PF/450PN6	450	17.2	1.775.000
PF/500PN6	500	19.1	2.164.000
PF/560PN6	560	21.4	2.972.000
PF/630PN6	630	24.1	3.765.000
PF/800PN6	800	30.6	6.072.000

**Ống nước HDPE PN8 - HDPE PN8 Pipes**

Mã số Code	de	e	Đơn giá Unit Price (VND/1m)
PF/20PN8	20	1.0	4.600
PF/25PN8	25	1.2	6.800
PF/32PN8	32	1.6	11.600
PF/40PN8	40	2.0	18.200
PF/50PN8	50	2.4	28.500
PF/63PN8	63	3.0	43.800
PF/75PN8	75	3.6	62.500
PF/90PN8	90	4.3	88.000
PF/110PN8	110	5.3	132.000
PF/125PN8	125	6.0	171.000
PF/140PN8	140	6.7	212.000
PF/160PN8	160	7.7	279.000
PF/180PN8	180	8.6	350.000

Mã số Code	de	e	Đơn giá Unit Price (VND/1m)
PF/200PN8	200	9.60	435.000
PF/225PN8	225	10.8	549.000
PF/250PN8	250	11.9	672.000
PF/280PN8	280	13.4	845.000
PF/315PN8	315	15.0	1.062.000
PF/355PN8	355	16.9	1.359.000
PF/400PN8	400	19.1	1.713.000
PF/450PN8	450	21.5	2.187.000
PF/500PN8	500	23.9	2.712.000
PF/560PN8	560	26.7	3.662.000
PF/630PN8	630	30.0	4.630.000
PF/800PN8	800	38.1	7.485.000

**Ống nước HDPE PN10 - HDPE PN10 Pipes**

Mã số Code	de	e	Đơn giá Unit Price (VND/1m)
PF/20PN10	20	1.2	5.500
PF/25PN10	25	1.5	10.600
PF/32PN10	32	2.0	14.800
PF/40PN10	40	2.4	22.200
PF/50PN10	50	3.0	34.500
PF/63PN10	63	3.8	54.800
PF/75PN10	75	4.5	77.500
PF/90PN10	90	5.4	112.000
PF/110PN10	110	6.6	163.000
PF/125PN10	125	7.4	208.000
PF/140PN10	140	8.3	261.000
PF/160PN10	160	9.5	341.000
PF/180PN10	180	10.7	432.000

Mã số Code	de	e	Đơn giá Unit Price (VND/1m)
PF/200PN10	200	11.9	537.000
PF/225PN10	225	13.4	678.000
PF/250PN10	250	14.8	833.000
PF/280PN10	280	16.6	1.046.000
PF/315PN10	315	18.7	1.324.000
PF/355PN10	355	21.1	1.669.000
PF/400PN10	400	23.7	2.131.000
PF/450PN10	450	26.7	2.675.000
PF/500PN10	500	29.7	3.328.000
PF/560PN10	560	33.2	4.500.000
PF/630PN10	630	37.4	5.700.000
PF/800PN10	800	48.8	9.185.000

**Ống nước HDPE PN12.5 - HDPE PN12.5 Pipes**

Mã số Code	de	e	Đơn giá Unit Price (VND/1m)
PF/20PN12.5	20	1.5	8.000
PF/25PN12.5	25	2.0	10.800
PF/32PN12.5	32	2.4	17.200
PF/40PN12.5	40	3.0	26.800
PF/50PN12.5	50	3.7	41.200
PF/63PN12.5	63	4.7	65.600
PF/75PN12.5	75	5.6	93.800
PF/90PN12.5	90	6.7	133.000
PF/110PN12.5	110	8.1	201.000
PF/125PN12.5	125	9.2	256.000
PF/140PN12.5	140	10.3	319.000
PF/160PN12.5	160	11.8	419.000
PF/180PN12.5	180	13.3	530.000

Mã số Code	de	e	Đơn giá Unit Price (VND/1m)
PF/200PN12.5	200	14.7	659.000
PF/225PN12.5	225	16.6	814.000
PF/250PN12.5	250	18.4	1.007.000
PF/280PN12.5	280	20.6	1.263.000
PF/315PN12.5	315	23.2	1.598.000
PF/355PN12.5	355	26.1	2.029.000
PF/400PN12.5	400	29.4	2.580.000
PF/450PN12.5	450	33.1	3.230.000
PF/500PN12.5	500	36.8	4.021.000
PF/560PN12.5	560	41.2	5.490.000
PF/630PN12.5	630	46.3	6.942.000
PF/800PN12.5	800	48.8	9.432.000

**Ống nước HDPE PN16 - HDPE PN16 Pipes**

Mã số Code	de	e	Đơn giá Unit Price (VND/1m)
PF/20PN16	20	2.0	8.200
PF/25PN16	25	2.3	12.600
PF/32PN16	32	3.0	20.800
PF/40PN16	40	3.7	32.000
PF/50PN16	50	4.6	49.800
PF/63PN16	63	5.8	79.000
PF/75PN16	75	6.8	110.000
PF/90PN16	90	8.2	159.000
PF/110PN16	110	10.0	238.000
PF/125PN16	125	11.4	310.000
PF/140PN16	140	12.7	382.000
PF/160PN16	160	14.6	502.000
PF/180PN16	180	16.4	637.000

Mã số Code	de	e	Đơn giá Unit Price (VND/1m)
PF/200PN16	200	18.2	785.000
PF/225PN16	225	20.5	982.000
PF/250PN16	250	22.7	1.228.000
PF/280PN16	280	25.4	1.540.000
PF/315PN16	315	28.6	1.924.000
PF/355PN16	355	32.2	2.442.000
PF/400PN16	400	36.3	3.099.000
PF/450PN16	450	40.9	4.082.000
PF/500PN16	500	45.4	5.056.000
PF/560PN16	560	50.8	6.635.000
PF/630PN16	630	57.2	7.882.000
PF/800PN16	800	72.6	13.563.000

**Ống nước HDPE PN20 - HDPE PN20 Pipes**

Mã số Code	de	e	Đơn giá Unit Price (VND/1m)
PF/16PN20	16	2.0	7.200
PF/20PN20	20	2.3	10.000
PF/25PN20	25	3.0	15.200
PF/32PN20	32	3.6	24.800
PF/40PN20	40	4.5	38.200
PF/50PN20	50	5.6	58.800
PF/63PN20	63	7.1	93.800
PF/75PN20	75	8.4	133.000
PF/90PN20	90	10.1	191.000
PF/110PN20	110	12.3	289.000
PF/125PN20	125	14.0	370.000
PF/140PN20	140	15.7	463.000

Mã số Code	de	e	Đơn giá Unit Price (VND/1m)
PF/160PN20	160	17.9	607.000
PF/180PN20	180	20.1	767.000
PF/200PN20	200	22.4	954.000
PF/225PN20	225	25.2	1.180.000
PF/250PN20	250	27.9	1.458.000
PF/280PN20	280	31.3	1.827.000
PF/315PN20	315	35.2	2.324.000
PF/355PN20	355	39.7	2.950.000
PF/400PN20	400	44.7	3.753.000
PF/450PN20	450	50.3	4.899.000
PF/500PN20	500	55.8	6.057.000

**Phụ kiện ống nước HDPE**
**Nối góc - Equal Elbow**

Mã số Code	D	L	Đơn giá Unit Price (VND)
FPD/EE20	20	68	24.800
FPD/EE25	25	75	28.200
FPD/EE32	32	80	38.500
FPD/EE40	40	95	61.200
FPD/EE50	50	120	78.800
FPD/EE63	63	135	134.000
FPD/EE75	75	-	187.000
FPD/EE90	90	-	315.000
FPD/EE110	110	-	748.000

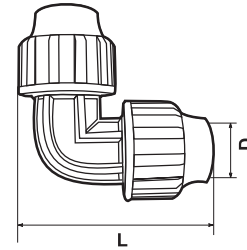
**Nối góc ren trong - Female Elbow**

Mã số Code	D	G	L	L1	Đơn giá Unit Price (VND)
FPD/FE20 x 1/2	20	1/2"	68	43	15.500
FPD/FE25 x 1/2	25	1/2"	-	-	20.000
FPD/FE25 x 3/4	25	3/4"	75	49	20.000
FPD/FE32 x 3/4	32	3/4"	-	-	30.000
FPD/FE32 x 1	32	1"	82	60	30.000
FPD/FE40 x 1 1/4	40	1 1/4"	100	65	52.800
FPD/FE50 x 1 1/2	50	1 1/2"	115	75	97.500
FPD/FE63 x 2	63	2"	135	85	132.000
FPD/FE75 x 2 1/2	75	2 1/2"	-	-	184.000
FPD/FE90 x 3	90	3"	-	-	297.000

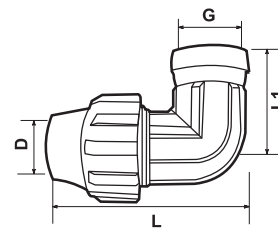
**Nối góc ren ngoài - Male Elbow**

Mã số Code	D	G	L	L1	Đơn giá Unit Price (VND)
FPD/ME20 x 1/2	20	1/2"	68	43	15.000
FPD/ME20 x 3/4	20	3/4"	-	-	15.000
FPD/ME25 x 1/2	25	1/2"	-	-	16.800
FPD/ME25 x 3/4	25	3/4"	75	50	16.800
FPD/ME25 x 1	25	1"	-	-	16.800
FPD/ME32 x 1/2	32	1/2"	-	-	24.800
FPD/ME32 x 3/4	32	3/4"	-	-	24.800
FPD/ME32 x 1	32	1"	80	60	24.800
FPD/ME40 x 1 1/4	40	1 1/4"	98	65	47.800
FPD/ME40 x 1 1/2	40	1 1/2"	-	-	47.800
FPD/ME50 x 1	50	1"	-	-	70.000
FPD/ME50 x 1 1/4	50	1 1/4"	-	-	70.000
FPD/ME50 x 1 1/2	50	1 1/2"	115	85	70.000
FPD/ME63 x 1 1/4	63	1 1/4"	-	-	106.000
FPD/ME63 x 1 1/2	63	1 1/2"	-	-	106.000
FPD/ME63 x 2	63	2"	135	85	106.000
FPD/ME90 x 3	90	3"	-	-	286.000

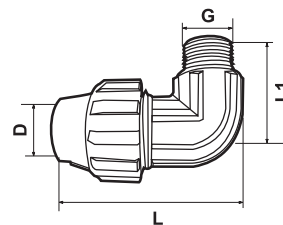
**Chú ý:**

Áp suất làm việc ở 20°C: 10bar - Working pressure 20°C: 10bar

**Tê đều - Equal Tee**

Mã số Code	D	L	L1	Đơn giá Unit Price (VND)
FPD/ET20	20	130	65	26.800
FPD/ET25	25	140	75	36.000
FPD/ET32	32	160	80	41.800
FPD/ET40	40	190	95	80.800
FPD/ET50	50	240	120	129.000
FPD/ET63	63	270	135	156.000
FPD/ET75	75	-	-	249.000
FPD/ET90	90	-	-	464.000
FPD/ET110	110	-	-	1.187.000

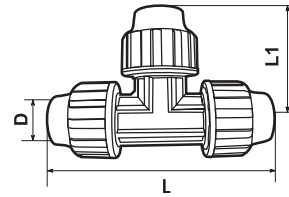
**Tê ren trong - Female Tee**

Mã số Code	D	G	L	L1	Đơn giá Unit Price (VND)
FPD/FT20 x 1/2	20	1/2"	135	45	24.000
FPD/FT25 x 1/2	25	1/2"	-	-	31.500
FPD/FT25 x 3/4	25	3/4"	150	50	31.500
FPD/FT32 x 3/4	32	3/4"	-	-	47.800
FPD/FT32 x 1	32	1"	162	60	47.800
FPD/FT40 x 1 1/4	40	1 1/4"	192	65	85.500
FPD/FT50 x 1 1/4	50	1 1/4"	-	-	137.000
FPD/FT50 x 1 1/2	50	1 1/2"	232	75	137.000
FPD/FT63 x 1 1/2	63	1 1/2"	-	-	186.000
FPD/FT63 x 2	63	2"	270	85	186.000
FPD/FT75 x 2 1/2	75	2 1/2"	-	-	298.000
FPD/FT90 x 2 1/2	90	2 1/2"	-	-	501.000
FPD/FT90 x 3	90	3"	-	-	501.000
FPD/FT110x4	110	4"	-	-	852.000

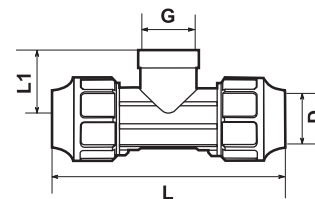
**Tê ren ngoài - Male Tee**

Mã số Code	D	G	L	L1	Đơn giá Unit Price (VND)
FPD/MT20 x 1/2	20	1/2"	130	48	24.200
FPD/MT20 x 3/4	20	3/4"	-	-	24.200
FPD/MT25 x 1/2	25	1/2"	-	-	32.200
FPD/MT25 x 3/4	25	3/4"	150	50	32.200
FPD/MT25 x 1	25	1"	-	-	32.200
FPD/MT32 x 1/2	32	1/2"	-	-	48.200
FPD/MT32 x 3/4	32	3/4"	-	-	48.200
FPD/MT32 x 1	32	1"	162	62	48.200
FPD/MT32 x 1 1/4	32	1 1/4"	-	-	48.200
FPD/MT40 x 1 1/4	40	1 1/4"	192	68	90.200
FPD/MT50 x 1 1/2	50	1 1/2"	232	80	125.000
FPD/MT50 x 2	50	2"	-	-	125.000
FPD/MT63 x 2	63	2"	270	85	177.000
FPD/MT75 x 2 1/2"	75	2 1/2"	-	-	283.000
FPD/MT90 x 3	90	3"	-	-	484.000

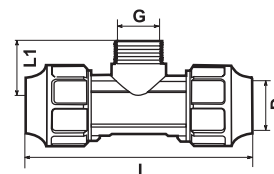

**Chú ý:**

Áp suất làm việc ở 20°C: 10bar - Working pressure 20°C: 10bar

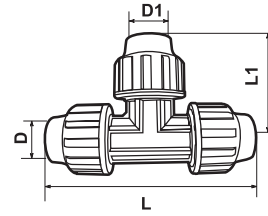

**Tê chuyển bậc - Reducing Tee**

Mã số Code	D	D1	L	L1	Đơn giá Unit Price (VND)
FPD/RT25 x 20	25	20	150	70	45.000
FPD/RT32 x 25	32	25	160	85	61.800
FPD/RT40 x 25	40	25	-	-	75.500
FPD/RT40 x 32	40	32	192	90	75.500
FPD/RT50 x 25	50	25	-	-	75.500
FPD/RT50 x 32	50	32	-	-	75.500
FPD/RT50 x 40	50	40	230	110	111.000
FPD/RT63 x 20	63	20	-	-	132.000
FPD/RT63 x 25	63	25	-	-	132.000
FPD/RT63 x 32	63	32	-	-	138.000
FPD/RT63 x 40	63	40	-	-	138.000
FPD/RT63 x 50	63	50	270	125	138.000
FPD/RT75 x 63	75	63	-	-	445.000

**Nối thẳng - Equal Coupling**

Mã số Code	D	L	Đơn giá Unit Price (VND)
FPD/EC20	20	108	20.000
FPD/EC25	25	120	29.500
FPD/EC32	32	125	38.800
FPD/EC40	40	150	56.800
FPD/EC50	50	180	74.200
FPD/EC63	63	215	97.500
FPD/EC75	75	-	161.000
FPD/EC90	90	-	279.000
FPD/EC110	110	-	736.000

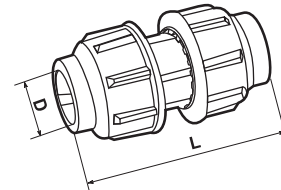
**Nối thẳng chuyển bậc - Reducing Coupling**

Mã số Code	D	D1	L	Đơn giá Unit Price (VND)
FPD/RC25 x 20	25	20	110	22.800
FPD/RC32 x 20	32	20	116	41.800
FPD/RC32 x 25	32	25	120	41.800
FPD/RC40 x 20	40	20	-	55.900
FPD/RC40 x 25	40	25	135	44.800
FPD/RC40 x 32	40	32	136	50.800
FPD/RC50 x 25	50	25	-	75.400
FPD/RC50 x 32	50	32	148	53.500
FPD/RC50 x 40	50	40	165	67.800
FPD/RC63 x 20	63	20	-	76.000
FPD/RC63 x 25	63	25	-	96.000
FPD/RC63 x 32	63	32	-	117.000
FPD/RC63 x 40	63	40	188	92.500
FPD/RC63 x 50	63	50	200	93.500
FPD/RC75 x 50	75	50	-	221.000
FPD/RC75 x 63	75	63	-	221.000
FPD/RC90 x 63	90	63	-	312.000
FPD/RC90 x 75	90	75	-	312.000
FPD/RC110 x 90	110	90	-	728.000

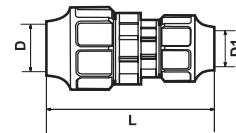
**Chú ý:**

Áp suất làm việc ở 20°C: 10bar - Working pressure 20°C: 10bar

**Đầu nối ren trong - Female Adaptor**

Mã số Code	D	G	L	Đơn giá Unit Price (VND)
FPD/FA20 x 1/2	20	1/2"	75	12.500
FPD/FA20 x 3/4	20	3/4"	-	13.000
FPD/FA25 x 1/2	25	1/2"	-	17.500
FPD/FA25 x 3/4	25	3/4"	82	17.500
FPD/FA32 x 3/4	32	3/4"	-	23.500
FPD/FA32 x 1	32	1"	90	23.500
FPD/FA40 x 1 1/4	40	1 1/4"	105	46.800
FPD/FA50 x 1 1/2	50	1 1/2"	115	72.500
FPD/FA63 x 2	63	2"	140	104.000
FPD/FA75 x 2 1/2	75	2 1/2"	-	134.000
FPD/FA90 x 3	90	3"	-	266.000
FPD/FA110 x 4	110	4"	-	453.000

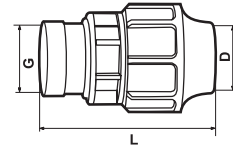
**Đầu nối ren ngoài - Male Adaptor**

Mã số Code	D	G	L	Đơn giá Unit Price (VND)
FPD/MA20 x 1/2	20	1/2"	75	14.200
FPD/MA20 x 3/4	20	3/4"	-	14.200
FPD/MA20 x 1	20	1"	-	14.200
FPD/MA25 x 1/2	25	1/2"	-	16.600
FPD/MA25 x 3/4	25	3/4"	82	16.600
FPD/MA25 x 1	25	1"	-	16.600
FPD/MA32 x 1/2	32	1/2"	-	19.500
FPD/MA32 x 3/4	32	3/4"	-	19.500
FPD/MA32 x 1	32	1"	90	19.500
FPD/MA32 x 1 1/4	32	1 1/4"	-	19.500
FPD/MA32 x 1 1/2	32	1 1/2"	-	19.500
FPD/MA40 x 1	40	1"	-	34.500
FPD/MA40 x 1 1/4	40	1 1/4"	102	34.500
FPD/MA40 x 1 1/2	40	1 1/2"	-	34.500
FPD/MA40 x 2	40	2"	-	34.500
FPD/MA50 x 3/4	50	3/4"	-	60.800
FPD/MA50 x 1	50	1"	-	60.800
FPD/MA50 x 1 1/4	50	1 1/4"	-	60.800
FPD/MA50 x 1 1/2	50	1 1/2"	118	60.800
FPD/MA50 x 2	50	2"	-	60.800
FPD/MA63 x 3/4	63	3/4"	-	71.800
FPD/MA63 x 1	63	1"	-	71.800
FPD/MA63 x 1 1/2	63	1 1/2"	-	71.800
FPD/MA63 x 2	63	2"	140	71.800
FPD/MA63 x 2 1/2	63	2 1/2"	-	71.800
FPD/MA75 x 2	75	2"	-	109.000
FPD/MA75 x 2 1/2	75	2 1/2"	-	109.000
FPD/MA75 x 3	75	3"	-	109.000
FPD/MA90 x 1 1/2	90	1 1/2"	-	178.000
FPD/MA90 x 2	90	2"	-	178.000
FPD/MA90 x 2 1/2	90	2 1/2"	-	178.000
FPD/MA90 x 3	90	3"	-	178.000
FPD/MA110 x 3	110	3"	-	411.000
FPD/MA110 x 4	110	4"	-	411.000

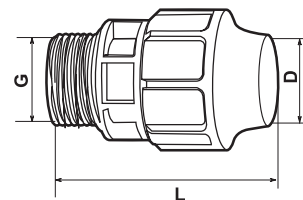
**Chú ý:**

Áp suất làm việc ở 20°C: 10bar - Working pressure 20°C: 10bar

**Đầu bịt - End Cap**

Mã số Code	D	L	Đơn giá Unit Price (VND)
FPD/CE20	20	54	10.500
FPD/CE25	25	60	12.200
FPD/CE32	32	62	20.000
FPD/CE40	40	75	35.000
FPD/CE50	50	90	49.000
FPD/CE63	63	108	73.800
FPD/CE75	75	-	114.000
FPD/CE90	90	-	182.000
FPD/CE110	110	-	526.000

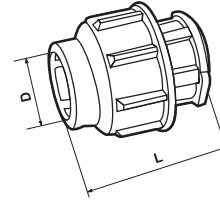
**Bích nhựa - Plastic Flange**

Mã số Code	Kích cỡ Size	Đơn giá Unit Price (VND)
FPD/PF40	40	154.000
FPD/PF50	50	170.000
FPD/PF63	63	235.000
FPD/PF75	75	274.000
FPD/PF90	90	377.000
FPD/PF110	110	539.000

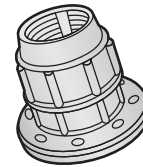
**Van ren ngoài - Female Valve**

Mã số Code	Kích cỡ Size	Đơn giá Unit Price (VND)
FPD/MV20	20	58.500
FPD/MV25	25	104.000
FPD/MV32	32	136.500
FPD/MV40	40	208.000
FPD/MV50	50	325.000
FPD/MV63	63	533.000

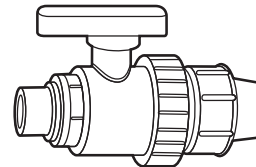
**Van ren trong - Male Valve**

Mã số Code	Kích cỡ Size	Đơn giá Unit Price (VND)
FPD/FV20	20	65.000
FPD/FV25	25	104.000
FPD/FV32	32	143.000
FPD/FV40	40	221.000
FPD/FV50	50	344.500
FPD/FV63	63	533.000

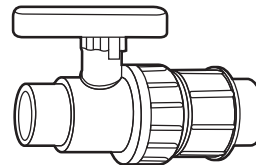
**Chú ý:**

Áp suất làm việc ở 20°C: 10bar - Working pressure 20°C: 10bar

**Van - Valve**

Mã số Code	Kích cỡ Size	Đơn giá Unit Price (VND)
FPD/V20	20	80.600
FPD/V25	25	130.000
FPD/V32	32	188.500
FPD/V40	40	325.000
FPD/V50	50	474.500
FPD/V63	63	734.500

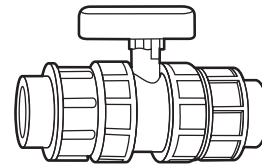
**Nối thẳng ren ngoài - Adaptor Bushes Equal**

Mã số Code	Kích cỡ Size	Đơn giá Unit Price (VND)
FPD/AR3/4 x 1/2	3/4 x 1/2"	4.600
FPD/AR1 x 1/2	1 x 1/2"	8.500
FPD/AR1 x 3/4	1 x 3/4"	8.500
FPD/AR1 1/2 x 1	1 1/2 x 1"	15.600
FPD/AR2 x 1 1/2	2 x 1 1/2"	41.600
FPD/AR3 x 2	3 x 2"	54.600

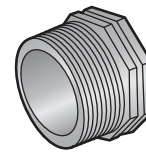
**Nối thẳng 2 đầu ren ngoài - Hexagon Nipples**

Mã số Code	Kích cỡ Size	Đơn giá Unit Price (VND)
FPD/HN3/4 x 1/2	3/4 x 1/2"	4.000
FPD/HN1 x 1/2	1 x 1/2"	7.800
FPD/HN1 x 3/4	1 x 3/4"	8.600
FPD/HN1 1/2 x 1/2	1 1/2 x 1/2"	14.300
FPD/HN1 1/2 x 3/4	1 1/2 x 3/4"	15.600
FPD/HN1 1/2 x 1	1 1/2 x 1"	18.200
FPD/HN2 x 3/4	2 x 3/4"	20.800
FPD/HN2 x 1	2 x 1"	22.100
FPD/HN2 x 1 1/2	2 x 1 1/2"	23.400
FPD/HN3 x 2	3 x 2"	47.500
FPD/HN3 x 2 1/2	3 x 2 1/2"	48.000

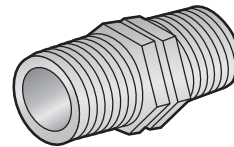

**Bích thép (mạ kẽm) - Slimflange Backing Rings (Galvanised mild steel)**

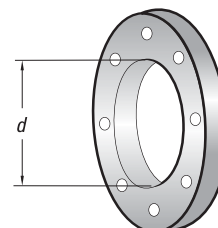
Mã số Code	Kích cỡ Size	d	Đơn giá Unit Price (VND)
FPD/SB40	40	48	217.000
FPD/SB50	50	58	250.500
FPD/SB63	63	71	324.200
FPD/SB75	75	83	364.800
FPD/SB90	90	98	410.000
FPD/SB110	110	108	572.000
FPD/SB180	180	188	941.500
FPD/SB200	200	208	1.368.000
FPD/SB225	225	235	1.436.500
FPD/SB250	250	260	1.508.500
FPD/SB280	280	290	1.757.500
FPD/SB315	315	325	1.966.500
FPD/SB355	355	365	2.407.200
FPD/SB400	400	410	3.026.500
FPD/SB450	450	460	3.932.500
FPD/SB500	500	512	4.790.500

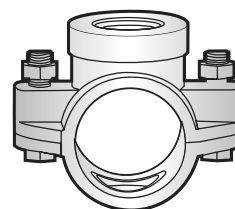

**Đại khởi thủy - Tapping Saddle**

Mã số Code	Kích cỡ Size	Đơn giá Unit Price (VND)
FPD/TS25 x 1/2	25 x 1/2"	22.800
FPD/TS25 x 3/4	25 x 3/4"	26.000
FPD/TS32 x 1/2	32 x 1/2"	24.800
FPD/TS32 x 3/4	32 x 3/4"	24.800
FPD/TS32 x 1	32 x 1"	24.800
FPD/TS40 x 1/2	40 x 1/2"	36.500
FPD/TS40 x 3/4	40 x 3/4"	36.500
FPD/TS40 x 1	40 x 1"	36.500
FPD/TS50 x 1/2	50 x 1/2"	44.200
FPD/TS50 x 3/4	50 x 3/4"	44.200
FPD/TS50 x 1	50 x 1"	44.200
FPD/TS63 x 1/2	63 x 1/2"	62.600
FPD/TS63 x 3/4	63 x 3/4"	62.600
FPD/TS63 x 1	63 x 1"	62.600
FPD/TS63 x 1 1/4	63 x 1 1/4"	62.000
FPD/TS75 x 1/2	75 x 1/2"	78.800
FPD/TS75 x 3/4	75 x 3/4"	78.800
FPD/TS75 x 1	75 x 1"	78.800
FPD/TS75 x 1 1/4	75 x 1 1/4"	78.800
FPD/TS75 x 1 1/2	75 x 1 1/2"	78.800
FPD/TS75 x 2	75 x 2"	78.800
FPD/TS90 x 1/2	90 x 1/2"	83.800
FPD/TS90 x 3/4	90 x 3/4"	83.800
FPD/TS90 x 1	90 x 1"	83.800
FPD/TS90 x 1 1/4	90 x 1 1/4"	83.800
FPD/TS90 x 1 1/2	90 x 1 1/2"	83.800
FPD/TS90 x 2	90 x 2"	127.500
FPD/TS110 x 1/2	110 x 1/2"	133.000
FPD/TS110 x 3/4	110 x 3/4"	133.000
FPD/TS110 x 1	110 x 1"	133.000
FPD/TS110 x 1 1/4	110 x 1 1/4"	133.000
FPD/TS110 x 1 1/2	110 x 1 1/2"	133.000
FPD/TS110 x 2	110 x 2"	127.500
FPD/TS110 x 3	110 x 3"	214.500
FPD/TS125 x 1	125 x 1"	214.500
FPD/TS125 x 1 1/4	125 x 1 1/4"	214.500
FPD/TS125 x 1 1/2	125 x 1 1/2"	214.500
FPD/TS125 x 2	125 x 2"	214.500
FPD/TS125 x 2 1/2	125 x 2 1/2"	214.500
FPD/TS140 x 2	140 x 2"	266.500
FPD/TS140 x 2 1/2	140 x 2 1/2"	266.500
FPD/TS160 x 1	160 x 1"	266.500
FPD/TS160 x 1 1/4	160 x 1 1/4"	266.500
FPD/TS160 x 1 1/2	160 x 1 1/2"	266.500
FPD/TS160 x 2	160 x 2"	266.500
FPD/TS160 x 2 1/2	160 x 2 1/2"	266.500
FPD/TS180 x 2	180 x 2"	455.000
FPD/TS180 x 2 1/2	180 x 2 1/2"	455.000
FPD/TS200 x 3/4	200 x 3/4"	611.000
FPD/TS200 x 1	200 x 1"	611.000
FPD/TS200 x 1 1/4	200 x 1 1/4"	611.000
FPD/TS200 x 1 1/2	200 x 1 1/2"	611.000
FPD/TS200 x 2	200 x 2"	611.000
FPD/TS200 x 2 1/2	200 x 2 1/2"	611.000
FPD/TS225 x 2	225 x 2"	745.000
FPD/TS225 x 2 1/2	225 x 2 1/2"	745.000
FPD/TS250 x 3/4	250 x 3/4"	884.000
FPD/TS250 x 1	250 x 1"	884.000
FPD/TS250 x 2	250 x 2"	884.000
FPD/TS250 x 2 1/2	250 x 2 1/2"	884.000
FPD/TS250 x 3	250 x 3"	884.000
FPD/TS250 x 4	250 x 4"	884.000
FPD/TS280 x 2	280 x 2"	977.000
FPD/TS280 x 2 1/2	280 x 2 1/2"	977.000



**Phụ kiện hàn - Fusion Fittings**
**Chức 22.5° - 22.5° Elbows**

Mã số Code	Kích cỡ Size	Đơn giá Unit Price (VND)
FPD/EC110	110	255.000
FPD/EC160	160	598.000
FPD/EC200	200	1.055.000
FPD/EC250	250	2.217.000
FPD/EC315	315	3.861.000
FPD/EC400	400	5.820.000

**Nối góc 45° hàn - Elbow 45°**

Mã số Code	ØD	L	Đơn giá Unit Price (VND)
FPD/EB90	90	150	64.000
FPD/EB110	110	150	129.200
FPD/EB125	125	150	168.500
FPD/EB140	140	150	213.500
FPD/EB160	160	150	282.000
FPD/EB180	180	200	361.600
FPD/EB200	200	200	539.000
FPD/EB225	225	200	693.200
FPD/EB250	250	200	922.500
FPD/EB280	280	200	1.219.500
FPD/EB315	315	300	1.796.500
FPD/EB355	355	300	2.572.500
FPD/EB400	400	300	3.310.500
FPD/EB450	450	300	4.275.500
FPD/EB500	500	300	5.698.500
FPD/EB560	560	-	11.046.500
FPD/EB630	630	-	15.055.500

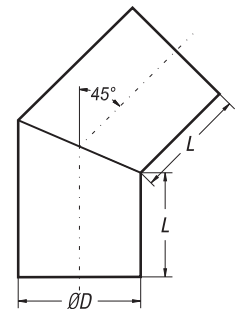
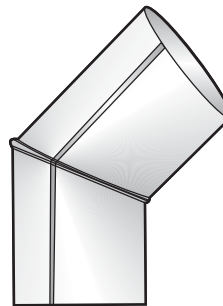

**Nối góc 90° hàn - Elbow 90°**

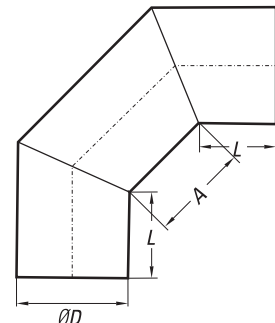
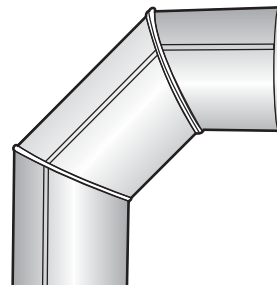
Mã số Code	ØD	L	A	Đơn giá Unit Price (VND)
FPD/EG90	90	150	150	85.500
FPD/EG110	110	150	150	164.000
FPD/EG125	125	150	150	215.600
FPD/EG140	140	150	150	275.000
FPD/EG160	160	150	150	365.000
FPD/EG180	180	200	150	472.800
FPD/EG200	200	200	150	692.500
FPD/EG225	225	200	150	897.800
FPD/EG250	250	200	150	1.217.500
FPD/EG280	280	200	150	1.569.500
FPD/EG315	315	300	200	2.304.000
FPD/EG355	355	300	200	3.300.800
FPD/EG400	400	300	200	4.286.500
FPD/EG450	450	300	200	5.769.000
FPD/EG500	500	300	200	7.544.800
FPD/EG560	560	-	-	15.836.500
FPD/EG630	630	-	-	20.742.000

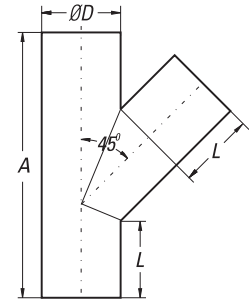
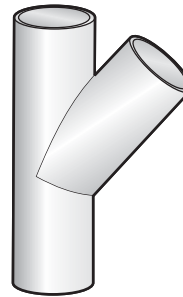

**Y 45° hàn - Y 45°**

Mã số Code	ØD	L	A	Đơn giá Unit Price (VND)
FPD/YT90	90	150	410	62.000
FPD/YT110	110	150	410	178.200
FPD/YT125	125	150	425	233.800
FPD/YT140	140	150	440	302.200
FPD/YT160	160	150	460	404.500
FPD/YT180	180	200	580	525.000
FPD/YT200	200	200	600	804.500
FPD/YT225	225	200	625	1.054.500
FPD/YT250	250	200	650	1.553.200
FPD/YT280	280	200	680	2.029.200
FPD/YT315	315	300	915	2.961.800
FPD/YT355	355	300	955	4.032.200
FPD/YT400	400	300	1000	5.282.200
FPD/YT450	450	300	1050	6.988.500
FPD/YT500	500	300	1100	8.977.500
FPD/YT560	560	-	-	19.123.000
FPD/YT630	630	-	-	25.350.500

**Y 60° hàn - Y 60°**

Mã số Code	ØD	L	A	Đơn giá Unit Price (VND)
FPD/YE90	90	150	410	62.000
FPD/YE110	110	150	410	178.200
FPD/YE125	125	150	425	233.800
FPD/YE140	140	150	440	302.200
FPD/YE160	160	150	460	404.500
FPD/YE180	180	200	580	525.000
FPD/YE200	200	200	600	804.500
FPD/YE225	225	200	625	1.054.500
FPD/YE250	250	200	650	1.553.200
FPD/YE280	280	200	680	2.029.200
FPD/YE315	315	300	915	2.961.800
FPD/YE355	355	300	955	4.032.200
FPD/YE400	400	300	1000	5.282.200
FPD/YE450	450	300	1050	6.988.500
FPD/YE500	500	300	1100	8.977.500
FPD/YE560	560	-	-	19.123.000
FPD/YE630	630	-	-	25.350.500

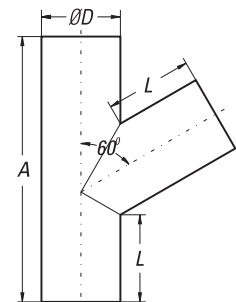
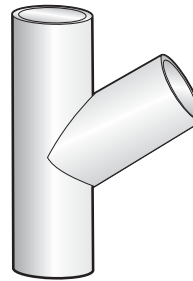

**Y thu 45° - Reducing Y Pieces 45°**

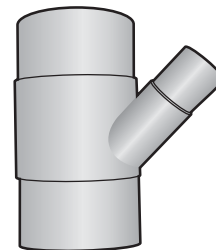
Mã số Code	Kích cỡ Size	Đơn giá Unit Price (VND)
FPD/YT7550	75 x 50	769.000
FPD/YT7563	75 x 63	826.500
FPD/YT9050	90 x 50	1.099.700
FPD/YT9063	90 x 63	1.237.000
FPD/YT9075	90 x 75	1.375.700
FPD/YT11063	110 x 63	1.787.500
FPD/YT11090	110 x 90	1.925.000
FPD/YT16063	160 x 63	2.750.000
FPD/YT16090	160 x 90	3.851.000
FPD/YT160110	160 x 110	4.125.500

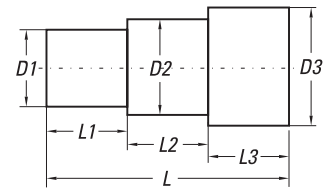
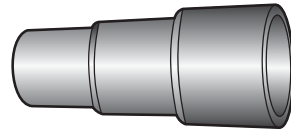

**Đầu nối chuyển bậc hàn - Coupling Reduced**

Mã số Code	D1 - D2 - D3	L	L1	L2	L3	Đơn giá Unit Price (VND)
FPD/CR907563	63 x 75 x 90	150	50	50	50	37.600
FPD/CR12511090	90 x 110 x 125	150	50	50	50	97.800
FPD/CR160140125	125 x 140 x 160	210	70	70	70	154.000
FPD/CR200180160	160 x 180 x 200	210	70	70	70	209.000

**Đầu nối bằng bích - Flange Adaptor**

Mã số Code	ØD	ØD1	L	A	Đơn giá Unit Price (VND)
FPD/AF63x90	63	90	130	20	65.800
FPD/AF75x110	75	110	130	20	97.200
FPD/AF90x125	90	125	130	20	113.000
FPD/AF110x140	110	140	255	20	150.000
FPD/AF125x160	125	160	200	38	236.000
FPD/AF140x180	140	180	200	40	371.800
FPD/AF160x200	160	200	200	20	357.500
FPD/AF180x218	180	218	255	25	517.000
FPD/AF200x250	200	250	255	27	603.000
FPD/AF225x268	225	268	255	27	786.500
FPD/AF250x315	250	320	255	30	925.000
FPD/AF280x320	280	320	255	30	1.442.000
FPD/AF315x370	315	370	255	33	1.573.000
FPD/AF355x385	355	385	340	36	1.781.000
FPD/AF400x450	400	450	340	36	2.075.000
FPD/AF450x500	450	500	350	38	2.934.000
FPD/AF500x555	500	555	350	40	3.419.000

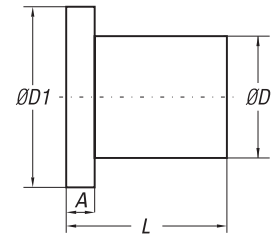
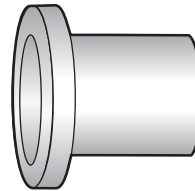
**Tê 90° hàn - Tees 90°**

Mã số Code	ØD	L	A	Đơn giá Unit Price (VND)
FPD/TD110	110	150	410	171.800
FPD/TD125	125	150	425	216.500
FPD/TD140	140	150	440	276.200
FPD/TD160	160	150	460	370.600
FPD/TD180	180	200	580	479.500
FPD/TD200	200	200	600	732.500
FPD/TD225	225	200	625	954.500
FPD/TD250	250	200	650	1.334.800
FPD/TD280	280	200	680	1.721.500
FPD/TD315	315	300	915	2.556.500
FPD/TD355	355	300	955	3.631.200
FPD/TD400	400	300	1000	4.718.200
FPD/TD450	450	300	1050	6.166.800
FPD/TD500	500	300	1100	8.167.800
FPD/TD560	560	-	-	15.182.800
FPD/TD630	630	-	-	17.962.500

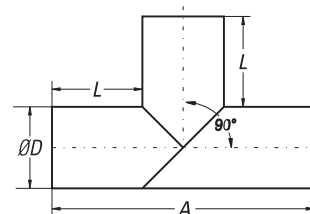
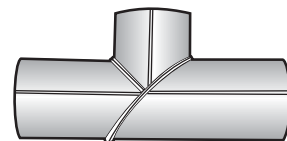



**Thập đều hàn - Cross**

Mã số Code	ØD	L	A	Đơn giá Unit Price (VND)
FPD/CS75	75			<b>82.500</b>
FPD/CS90	90	150	390	<b>135.000</b>
FPD/CS110	110	150	410	<b>223.000</b>
FPD/CS125	125	150	425	<b>290.000</b>
FPD/CS140	140	150	440	<b>369.000</b>
FPD/CS160	160	150	460	<b>489.000</b>
FPD/CS180	180	200	580	<b>692.000</b>
FPD/CS200	200	200	600	<b>967.000</b>
FPD/CS225	225	200	625	<b>1.251.000</b>
FPD/CS250	250	200	650	<b>1.752.000</b>
FPD/CS280	280	200	680	<b>2.243.000</b>
FPD/CS315	315	300	915	<b>2.919.000</b>
FPD/CS355	355	300	955	<b>4.744.000</b>
FPD/CS400	400	300	1000	<b>6.113.000</b>
FPD/CS450	450	300	1050	<b>7.924.000</b>
FPD/CS500	500	300	1100	<b>10.458.000</b>
FPD/CS560	560	-	-	<b>19.669.000</b>
FPD/CS630	630	-	-	<b>23.417.000</b>

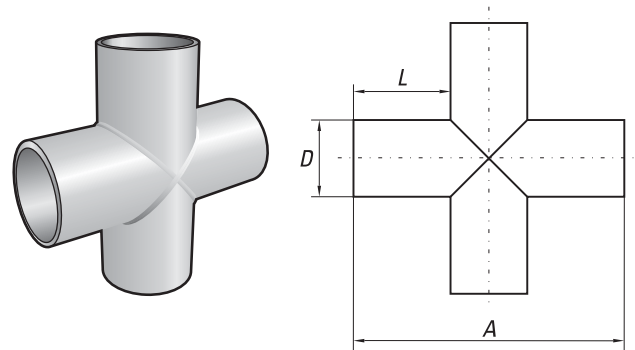

**Đầu bịt - End Cap**

Mã số Code	Kích cỡ Size	Đơn giá Unit Price (VND)
FPD/DB63	63	<b>38.200</b>
FPD/DB75	75	<b>42.000</b>
FPD/DB90	90	<b>66.800</b>
FPD/DB110	110	<b>87.500</b>
FPD/DB125	125	<b>192.000</b>
FPD/DB140	140	<b>323.500</b>
FPD/DB160	160	<b>389.800</b>
FPD/DB180	180	<b>455.800</b>
FPD/DB200	200	<b>584.500</b>
FPD/DB225	225	<b>712.800</b>
FPD/DB250	250	<b>847.500</b>
FPD/DB280	280	<b>1.319.000</b>
FPD/DB315	315	<b>1.412.500</b>
FPD/DB355	355	<b>2.136.200</b>
FPD/DB400	400	<b>3.025.000</b>
FPD/DB450	450	<b>4.158.000</b>
FPD/DB500	500	<b>5.414.200</b>
FPD/DB560	560	<b>6.996.000</b>
FPD/DB630	630	<b>8.273.200</b>



**Phụ kiện hàn nối đầu - Butt Fusion Fittings**
**Tê thu nối hàn - Fabricated Reducing Tee Assembly**

Mã số Code	Kích cỡ Size	Đơn giá Unit Price (VND)
FPDFF/TA20050	200 x 50	783.000
FPDFF/TA200110	200 x 110	787.000
FPDFF/TA200125	200 x 125	790.000
FPDFF/TA200160	200 x 160	793.000
FPDFF/TA22550	225 x 50	972.000
FPDFF/TA225125	225 x 125	982.000
FPDFF/TA225160	225 x 160	985.000
FPDFF/TA225200	225 x 200	991.000
FPDFF/TA25050	250 x 50	1.258.000
FPDFF/TA250160	250 x 160	1.273.000
FPDFF/TA250200	250 x 200	1.282.000
FPDFF/TA250225	250 x 225	1.288.000
FPDFF/TA280160	280 x 160	1.582.000
FPDFF/TA280200	280 x 200	1.597.000
FPDFF/TA31550	315 x 50	1.999.000
FPDFF/TA315180	315 x 180	2.032.000
FPDFF/TA315200	315 x 200	2.032.000
FPDFF/TA315225	315 x 225	2.047.000
FPDFF/TA315250	315 x 250	2.057.000
FPDFF/TA315280	315 x 280	2.063.000
FPDFF/TA35550	355 x 50	3.150.000
FPDFF/TA355180	355 x 180	3.202.000
FPDFF/TA355200	355 x 200	3.211.000
FPDFF/TA355225	355 x 225	3.226.000
FPDFF/TA355250	355 x 250	3.241.000
FPDFF/TA355280	355 x 280	3.250.000
FPDFF/TA355315	355 x 315	3.263.000
FPDFF/TA40050	400 x 50	4.069.000
FPDFF/TA400200	400 x 200	4.372.500
FPDFF/TA400225	400 x 225	4.391.500
FPDFF/TA400250	400 x 250	4.411.200
FPDFF/TA400280	400 x 280	4.439.500
FPDFF/TA400315	400 x 315	4.443.000
FPDFF/TA400355	400 x 355	4.451.200
FPDFF/TA450180	450 x 180	5.330.000
FPDFF/TA450200	450 x 200	5.480.800
FPDFF/TA450225	450 x 225	5.681.000
FPDFF/TA450250	450 x 250	5.707.000
FPDFF/TA450280	450 x 280	5.722.000
FPDFF/TA450315	450 x 315	5.742.000
FPDFF/TA450355	450 x 355	5.758.000
FPDFF/TA450400	450 x 400	5.809.000
FPDFF/TA500180	500 x 180	6.945.600
FPDFF/TA500200	500 x 200	6.980.600
FPDFF/TA500225	500 x 225	7.238.500
FPDFF/TA500250	500 x 250	7.279.500
FPDFF/TA500280	500 x 280	7.306.000
FPDFF/TA500315	500 x 315	7.338.000
FPDFF/TA500355	500 x 355	7.364.000
FPDFF/TA500400	500 x 400	7.447.000
FPDFF/TA500450	500 x 450	7.530.000
FPDFF/TA560225	560 x 225	9.516.000
FPDFF/TA560280	560 x 280	10.372.000
FPDFF/TA560315	560 x 315	11.182.000
FPDFF/TA630180	630 x 180	12.391.500
FPDFF/TA630200	630 x 200	12.782.000
FPDFF/TA630225	630 x 225	12.900.000
FPDFF/TA630250	630 x 250	13.250.000
FPDFF/TA630280	630 x 280	13.492.000
FPDFF/TA630315	630 x 315	13.507.000
FPDFF/TA630355	630 x 355	13.900.000
FPDFF/TA630400	630 x 400	14.561.000
FPDFF/TA630450	630 x 450	14.972.000
FPDFF/TA630500	630 x 500	15.633.000

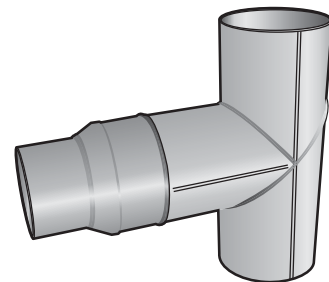

**Cút thu nối đầu (côn thu) - Reducing Sockets (plain)**

Mã số Code	Kích cỡ Size	Đơn giá Unit Price (VND)
FPD/RS75x50	75 x 50	45.500
FPD/RS75x63	75 x 63	53.000
FPD/RS90x50	90 x 50	64.800
FPD/RS90x63	90 x 63	72.600
FPD/RS90x75	90 x 75	82.500
FPD/RS110x50	110 x 50	82.500
FPD/RS110x63	110 x 63	98.200
FPD/RS110x75	110 x 75	119.000
FPD/RS110x90	110 x 90	121.000
FPD/RS125x50	125 x 50	208.000
FPD/RS125x63	125 x 63	208.000
FPD/RS125x75	125 x 75	231.500
FPD/RS125x90	125 x 90	235.500
FPD/RS125x110	125 x 110	272.200
FPD/RS140x63	140 x 63	296.500
FPD/RS140x75	140 x 75	329.200
FPD/RS140x90	140 x 90	361.500
FPD/RS140x110	140 x 110	423.500
FPD/RS140x125	140 x 125	453.800
FPD/RS160x63	160 x 63	498.000
FPD/RS160x75	160 x 75	510.500
FPD/RS160x90	160 x 90	521.200
FPD/RS160x110	160 x 110	543.600
FPD/RS160x125	160 x 125	572.000
FPD/RS160x140	160 x 140	605.000
FPD/RS180x90	180 x 90	805.500
FPD/RS180x110	180 x 110	805.500
FPD/RS180x125	180 x 125	819.500
FPD/RS180x140	180 x 140	950.500
FPD/RS180x160	180 x 160	1.009.800
FPD/RS200x63	200 x 63	1.087.000
FPD/RS200x75	200 x 75	1.095.000
FPD/RS200x90	200 x 90	1.110.000
FPD/RS200x110	200 x 110	1.128.000
FPD/RS200x125	200 x 125	1.142.000
FPD/RS200x160	200 x 160	1.152.000
FPD/RS200x180	200 x 180	1.166.000
FPD/RS225x90	225 x 90	1.210.000
FPD/RS225x110	225 x 110	1.226.000
FPD/RS225x125	225 x 125	1.242.000
FPD/RS225x160	225 x 160	1.250.000
FPD/RS225x200	225 x 200	1.250.000
FPD/RS250x90	250 x 90	1.300.000
FPD/RS250x110	250 x 110	1.315.600
FPD/RS250x125	250 x 125	1.367.000
FPD/RS250x160	250 x 160	1.388.000
FPD/RS250x200	250 x 200	1.392.200
FPD/RS250x225	250 x 225	1.430.000
FPD/RS280x110	280 x 110	1.798.500
FPD/RS280x200	280 x 200	1.982.200
FPD/RS280x225	280 x 225	2.098.800
FPD/RS280x250	280 x 250	2.194.500
FPD/RS315x90	315 x 90	2.398.000
FPD/RS315x110	315 x 110	2.416.000
FPD/RS315x125	315 x 125	2.452.000
FPD/RS315x160	315 x 160	2.468.000
FPD/RS315x200	315 x 200	2.489.000

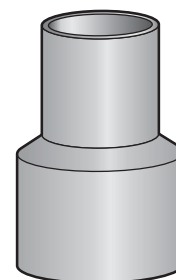

**Cút thu (côn thu) - Reducing Sockets (plain)**

Mã số Code	Kích cỡ Size	Đơn giá Unit Price (VND)
FPD/RS315x225	315 x 225	2.502.000
FPD/RS315x250	315 x 250	2.512.000
FPD/RS315x280	315 x 280	2.541.000
FPD/RS355x110	355 x 110	2.722.000
FPD/RS355x160	355 x 160	2.780.000
FPD/RS355x200	355 x 200	2.807.200
FPD/RS355x250	355 x 250	3.184.000
FPD/RS355x280	355 x 280	3.270.000
FPD/RS355x315	355 x 315	3.531.000
FPD/RS400x110	400 x 110	3.545.500
FPD/RS400x160	400 x 160	3.801.600
FPD/RS400x200	400 x 200	4.356.000
FPD/RS400x225	400 x 225	4.522.000
FPD/RS400x250	400 x 250	4.576.000
FPD/RS400x315	400 x 315	4.576.000
FPD/RS400x355	400 x 355	4.968.000
FPD/RS450x110	450 x 110	8.003.600
FPD/RS450x160	450 x 160	8.009.000
FPD/RS450x200	450 x 200	8.085.000
FPD/RS450x225	450 x 225	8.316.000
FPD/RS450x250	450 x 250	8.520.500
FPD/RS450x315	450 x 315	8.792.000
FPD/RS450x355	450 x 355	8.866.000
FPD/RS450x400	450 x 400	8.922.000
FPD/RS500x200	500 x 200	9.016.000
FPD/RS500x250	500 x 250	9.198.000
FPD/RS500x315	500 x 315	9.356.000
FPD/RS500x355	500 x 355	9.412.000
FPD/RS500x400	500 x 400	9.568.000
FPD/RS500x450	500 x 450	9.592.000
FPD/RS560x315	560 x 315	9.792.000
FPD/RS560x355	560 x 355	9.889.000
FPD/RS560x400	560 x 400	9.998.000
FPD/RS560x450	560 x 450	10.120.000
FPD/RS560x500	560 x 500	10.260.000
FPD/RS630x200	630 x 200	18.150.000
FPD/RS630x250	630 x 250	19.239.000
FPD/RS630x315	630 x 315	19.239.000
FPD/RS630x355	630 x 355	19.239.000
FPD/RS630x400	630 x 400	19.239.000
FPD/RS630x450	630 x 450	19.239.000
FPD/RS630x500	630 x 500	19.239.000
FPD/RS630x560	630 x 560	19.239.000

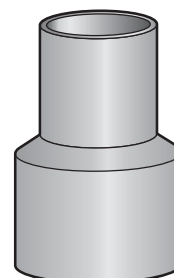

### Đầu bịt - End Cap

Mã số Code	Kích cỡ Size	L	A	Đơn giá Unit Price (VND)
FPDBF/DB20	20	45	41	
FPDBF/DB25	25	46	41	
FPDBF/DB32	32	51	45	
FPDBF/DB40	40	87	67	
FPDBF/DB50	50	90	66	
FPDBF/DB63	63	77	63	
FPDBF/DB75	75	84	70	
FPDBF/DB90	90	92	79	
FPDBF/DB110	110	97	82	
FPDBF/DB125	125	112	87	
FPDBF/DB160	160	119	98	
FPDBF/DB180	180	145	110	
FPDBF/DB200	200	147	112	
FPDBF/DB225	225	155	118	
FPDBF/DB250	250	186	128	
FPDBF/DB315	315	190	150	
FPDBF/DB355	355	215	155	
FPDBF/DB400	400	220	160	
FPDBF/DB500	500	240	190	
FPDBF/DB630	630	240	190	

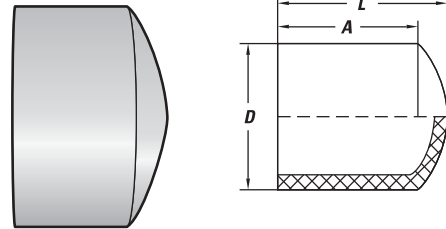

### Thập đều hàn - Cross

Mã số Code	Kích cỡ Size	L	A	H	Đơn giá Unit Price (VND)
FPDBF/CS63	63	230	63	115	
FPDBF/CS90	90	295	79	147	
FPDBF/CS110	110	380	82	190	
FPDBF/CS160	160	430	98	215	
FPDBF/CS200	200	420	90	210	
FPDBF/CS250	250	500	110	250	
FPDBF/CS315	315	615	130	307	
FPDBF/CS355	355	660	130	330	

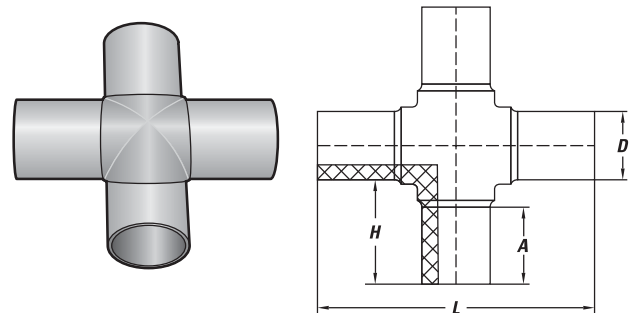

### Tê đều - Equal Tee

Mã số Code	Kích cỡ Size	L	A	B	H	Đơn giá Unit Price (VND)
FPDBF/T50	50	170	55	55	82	
FPDBF/T63	63	200	63	63	104	
FPDBF/T75	75	230	70	70	114	
FPDBF/T90	90	260	79	79	133	
FPDBF/T110	110	290	82	82	145	
FPDBF/T125	125	315	87	87	160	
FPDBF/T140	140	345	92	92	170	
FPDBF/T160	160	325	75	75	170	
FPDBF/T180	180	420	105	105	225	
FPDBF/T200	200	377	84	84	200	
FPDBF/T225	225	484	120	120	230	
FPDBF/T250	250	517	120	120	265	
FPDBF/T280	280	590	140	140	300	
FPDBF/T315	315	615	125	125	310	
FPDBF/T355	355	630	120	120	350	
FPDBF/T400	400	670	120	120	360	

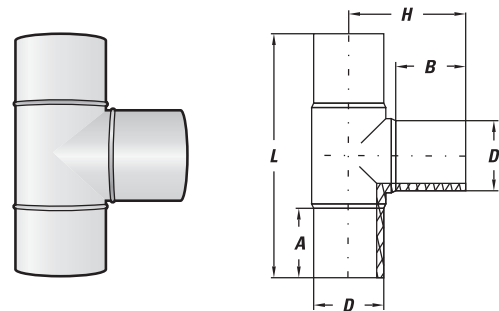

**Tê thu - Reducing Tee**

Mã số Code	Kích cỡ Size (D1 x D2)	L	A	B	H	Đơn giá Unit Price (VND)
FPDBF/TT5032	50 x 32	165	55	55	81	
FPDBF/TT6325	63 x 25	168	63	45	85	
FPDBF/TT6332	63 x 32	172	63	45	87	
FPDBF/TT6340	63 x 40	180	63	50	93	
FPDBF/TT6350	63 x 50	190	63	55	96	
FPDBF/TT7532	75 x 32	180	70	39	90	
FPDBF/TT7540	75 x 40	205	70	45	93	
FPDBF/TT7550	75 x 50	205	70	55	100	
FPDBF/TT7563	75 x 63	225	70	63	107	
FPDBF/TT9032	90 x 32	215	79	45	105	
FPDBF/TT9040	90 x 40	220	79	50	108	
FPDBF/TT9050	90 x 50	230	79	55	110	
FPDBF/TT9063	90 x 63	245	79	63	118	
FPDBF/TT9075	90 x 75	252	79	70	126	
FPDBF/TT11032	110 x 32	220	82	50	115	
FPDBF/TT11040	110 x 40	230	82	50	119	
FPDBF/TT11050	110 x 50	238	82	55	123	
FPDBF/TT11063	110 x 63	250	82	63	118	
FPDBF/TT11075	110 x 75	264	82	70	137	
FPDBF/TT11090	110 x 90	275	82	79	135	
FPDBF/TT12563	125 x 63	320	87	63	143	
FPDBF/TT12575	125 x 75	314	87	70	152	
FPDBF/TT12590	125 x 90	309	87	79	151	
FPDBF/TT125110	125 x 110	318	87	82	160	
FPDBF/TT140110	140 x 110	315	92	82	164	
FPDBF/TT140125	140 x 125	330	92	87	167	
FPDBF/TT16063	160 x 63	275	98	63	153	
FPDBF/TT16075	160 x 75	287	98	70	167	
FPDBF/TT16090	160 x 90	300	98	79	175	
FPDBF/TT160110	160 x 110	325	98	82	175	
FPDBF/TT160125	160 x 125	335	98	87	181	
FPDBF/TT160140	160 x 140	345	98	92	186	
FPDBF/TT18090	180 x 90	338	105	79	181	
FPDBF/TT180110	180 x 110	355	105	82	187	
FPDBF/TT180125	180 x 125	365	105	87	191	
FPDBF/TT180140	180 x 140	380	105	92	196	
FPDBF/TT180160	180 x 160	400	105	98	202	
FPDBF/TT20063	200 x 63	305	112	63	176	
FPDBF/TT20075	200 x 75	310	112	70	183	
FPDBF/TT20090	200 x 90	330	112	79	191	
FPDBF/TT200110	200 x 110	355	112	82	196	
FPDBF/TT200125	200 x 125	370	112	87	201	
FPDBF/TT200160	200 x 160	420	112	98	207	
FPDBF/TT22590	225 x 90	345	120	79	207	
FPDBF/TT225110	225 x 110	365	120	82	212	
FPDBF/TT225160	225 x 160	417	120	98	212	
FPDBF/TT225180	225 x 180	433	95	86	209	
FPDBF/TT25090	250 x 90	395	129	79	218	
FPDBF/TT250110	250 x 110	395	129	82	216	
FPDBF/TT250125	250 x 125	410	129	87	221	
FPDBF/TT250160	250 x 160	398	95	81	218	
FPDBF/TT250180	250 x 180	460	129	105	245	
FPDBF/TT250200	250 x 200	379	75	112	254	
FPDBF/TT28090	280 x 90	410	140	79	235	
FPDBF/TT280110	280 x 110	430	140	82	238	
FPDBF/TT280160	280 x 160	480	140	98	254	
FPDBF/TT280200	280 x 200	520	140	112	268	
FPDBF/TT280225	280 x 225	545	140	122	278	
FPDBF/TT280250	280 x 250	570	140	129	285	

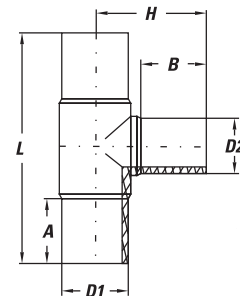
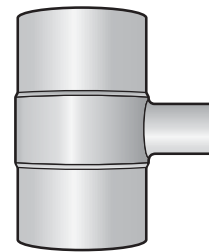

### Tê thu - Reducing Tee

Mã số Code	Kích cỡ Size	L	A	B	H	Đơn giá Unit Price (VND)
FPDBF/TT31590	315 x 90	420	150	79	255	
FPDBF/TT315110	315 x 110	442	150	82	255	
FPDBF/TT315160	315 x 160	450	130	77	247	
FPDBF/TT315180	315 x 180	503	150	105	291	
FPDBF/TT315200	315 x 200	455	110	95	285	
FPDBF/TT315225	315 x 225	550	150	120	292	
FPDBF/TT315250	315 x 250	460	80	80	248	
FPDBF/TT355250	355 x 250	620	120	120	290	
FPDBF/TT355315	355 x 315	620	120	120	290	
FPDBF/TT400200	400 x 200	670	130	150	380	
FPDBF/TT400315	400 x 315	670	130	150	380	
FPDBF/TT400355	400 x 355	670	130	150	380	

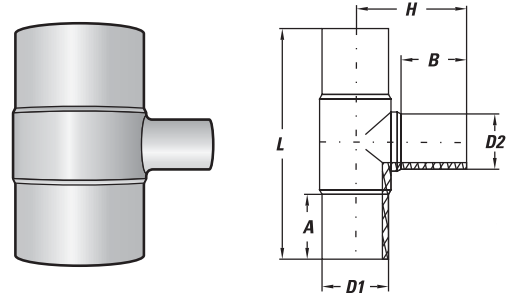

### Nối thu - Reducer

Mã số Code	Kích cỡ Size	L	A	B	Đơn giá Unit Price (VND)
FPDBF/RS6325	63 x 25	139	63	55	
FPDBF/RS6332	63 x 32	147	63	55	
FPDBF/RS6340	63 x 40	141	63	55	
FPDBF/RS6350	63 x 50	150	63	55	
FPDBF/RS7532	75 x 32	149	70	55	
FPDBF/RS7550	75 x 50	143	70	55	
FPDBF/RS7563	75 x 63	150	70	63	
FPDBF/RS9032	90 x 32	163	79	55	
FPDBF/RS9040	90 x 40	162	79	55	
FPDBF/RS9050	90 x 50	161	79	55	
FPDBF/RS9063	90 x 63	168	79	63	
FPDBF/RS9075	90 x 75	169	79	70	
FPDBF/RS11040	110 x 40	169	82	55	
FPDBF/RS11050	110 x 50	166	82	55	
FPDBF/RS11063	110 x 63	173	82	63	
FPDBF/RS11075	110 x 75	181	82	70	
FPDBF/RS11090	110 x 90	177	82	79	
FPDBF/RS12563	125 x 63	189	87	63	
FPDBF/RS12590	125 x 90	183	87	79	
FPDBF/RS125110	125 x 110	185	87	82	
FPDBF/RS14090	140 x 90	224	92	79	
FPDBF/RS140110	140 x 110	220	92	82	
FPDBF/RS16032	160 x 32	202	98	70	
FPDBF/RS16063	160 x 63	195	98	63	
FPDBF/RS16075	160 x 75	204	98	70	
FPDBF/RS16090	160 x 90	212	98	79	
FPDBF/RS160110	160 x 110	211	98	82	
FPDBF/RS160125	160 x 125	216	98	87	
FPDBF/RS18090	180 x 90	231	110	79	
FPDBF/RS180110	180 x 110	219	110	82	
FPDBF/RS180125	180 x 125	233	105	87	
FPDBF/RS180160	180 x 160	229	105	87	
FPDBF/RS20063	200 x 63	210	112	63	
FPDBF/RS20090	200 x 90	220	108	79	
FPDBF/RS200110	200 x 110	228	112	82	
FPDBF/RS200125	200 x 125	220	112	90	
FPDBF/RS200160	200 x 160	226	112	85	
FPDBF/RS200180	200 x 180	245	112	105	
FPDBF/RS22590	225 x 90	226	105	79	
FPDBF/RS225110	225 x 110	245	105	82	
FPDBF/RS225160	225 x 160	249	105	90	

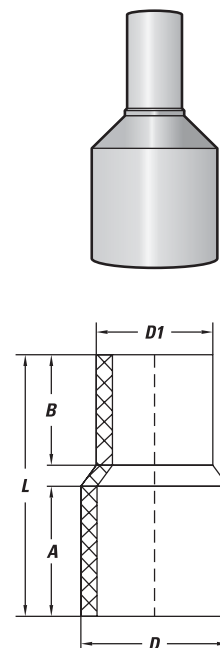

**Nối thu - Reducer**

Mã số Code	Kích cỡ Size	L	A	B	Đơn giá Unit Price (VND)
FPDBF/RS225180	225 x 180	249	105	90	
FPDBF/RS225200	225 x 200	246	105	90	
FPDBF/RS25090	250 x 90	224	112	79	
FPDBF/RS250110	250 x 110	221	108	82	
FPDBF/RS250125	250 x 125	234	109	87	
FPDBF/RS250160	250 x 160	244	110	98	
FPDBF/RS250180	250 x 180	237	110	105	
FPDBF/RS250200	250 x 200	250	110	103	
FPDBF/RS250225	250 x 225	231	105	90	
FPDBF/RS280160	280 x 160	257	107	85	
FPDBF/RS280225	280 x 225	247	110	85	
FPDBF/RS280250	280 x 250	247	110	90	
FPDBF/RS31590	315 x 90	240	115	79	
FPDBF/RS315110	315 x 110	241	115	82	
FPDBF/RS315160	315 x 160	254	115	98	
FPDBF/RS315180	315 x 180	253	115	100	
FPDBF/RS315200	315 x 200	253	115	92	
FPDBF/RS315225	315 x 225	245	115	90	
FPDBF/RS315250	315 x 250	246	115	90	
FPDBF/RS355200	355 x 200	270	100	100	
FPDBF/RS355250	355 x 250	270	100	100	
FPDBF/RS355280	355 x 280	260	100	100	
FPDBF/RS355315	355 x 315	240	100	100	
FPDBF/RS400200	400 x 200	260	100	100	
FPDBF/RS400250	400 x 250	250	100	100	
FPDBF/RS400315	400 x 315	250	100	100	
FPDBF/RS400355	400 x 355	250	100	100	
FPDBF/RS450200	450 x 200	260	100	100	
FPDBF/RS450250	450 x 250	260	100	100	
FPDBF/RS450315	450 x 315	250	100	100	
FPDBF/RS450355	450 x 355	250	100	100	
FPDBF/RS450400	450 x 400	240	100	100	
FPDBF/RS500400	500 x 400	250	100	100	
FPDBF/RS500450	500 x 450	250	100	100	
FPDBF/RS560500	560 x 500	260	100	100	
FPDBF/RS630500	630 x 500	260	100	100	
FPDBF/RS710630	710 x 630	250	100	100	
FPDBF/RS800710	800 x 710	250	100	100	

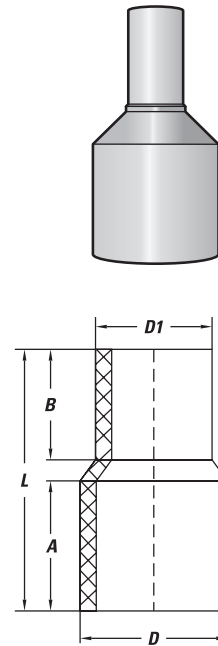
**Nối góc 90° - Elbow 90°**

Mã số Code	Kích cỡ Size	L	A	Đơn giá Unit Price (VND)
FPDBF/GV50	50	120	55	
FPDBF/GV63	63	133	63	
FPDBF/GV75	75	163	70	
FPDBF/GV90	90	182	79	
FPDBF/GV110	110	214	82	
FPDBF/GV125	125	240	87	
FPDBF/GV140	140	244	88	
FPDBF/GV160	160	258	80	
FPDBF/GV180	180	297	97	
FPDBF/GV200	200	308	97	
FPDBF/GV225	225	367	115	
FPDBF/GV250	250	362	100	
FPDBF/GV280	280	433	130	
FPDBF/GV315	315	460	125	
FPDBF/GV355	355	540	150	
FPDBF/GV400	400	600	180	

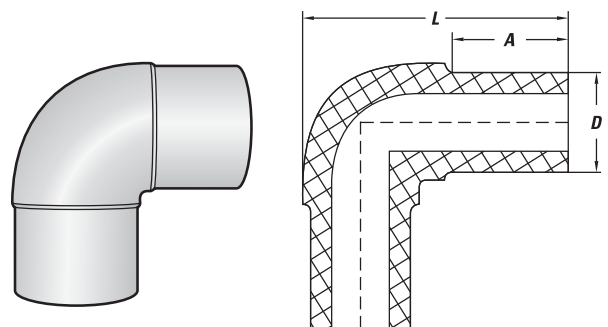



**Nối chếc 45° - Elbow 45°**

Mã số Code	Kích cỡ Size	L	A	B	Đơn giá Unit Price (VND)
FPDBF/CH63	63	160	63	79	
FPDBF/CH75	75	180	70	89	
FPDBF/CH90	90	228	79	114	
FPDBF/CH110	110	246	82	118	
FPDBF/CH125	125	248	87	115	
FPDBF/CH160	160	310	98	138	
FPDBF/CH180	180	340	100	159	
FPDBF/CH200	200	355	112	167	
FPDBF/CH225	225	398	120	173	
FPDBF/CH250	250	420	129	192	
FPDBF/CH315	315	510	150	220	

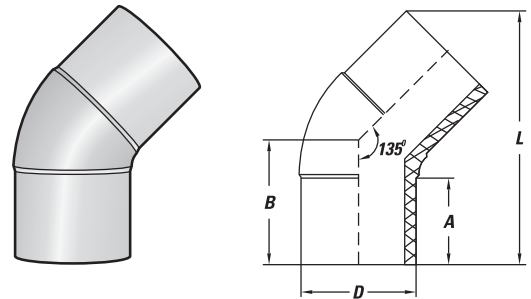

**Đầu nối bằng bích - Flange adaptor**

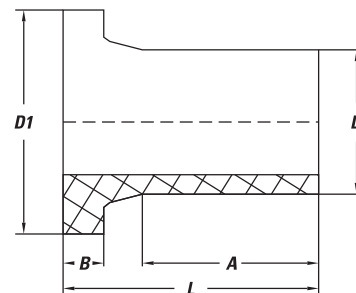
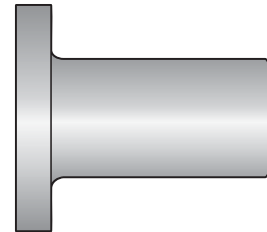
Mã số Code	Kích cỡ Size	L	A	B	Đơn giá Unit Price (VND)
FPDBF/AF2044	20 x 44	83	62	7	
FPDBF/AF2544	25 x 44	83	61	8	
FPDBF/AF3267	32 x 67	83	62	10	
FPDBF/AF4077	40 x 77	78	61	12	
FPDBF/AF5087	50 x 87	88	71	12	
FPDBF/AF63110	63 x 110	88	70	12	
FPDBF/AF75121	75 x 121	94	75	13	
FPDBF/AF90137	90 x 137	98	76	18	
FPDBF/AF110158	110 x 158	106	81	18	
FPDBF/AF125158	125 x 158	130	103	21	
FPDBF/AF140187	140 x 187	128	99	22	
FPDBF/AF160212	160 x 212	135	104	26	
FPDBF/AF180212	180 x 212	137	101	29	
FPDBF/AF200268	200 x 268	154	113	34	
FPDBF/AF225267	225 x 267	144	108	29	
FPDBF/AF250320	250 x 320	156	120	29	
FPDBF/AF280323	280 x 323	168	128	35	
FPDBF/AF315370	315 x 370	173	133	33	
FPDBF/AF355432	355 x 432	173	132	33	
FPDBF/AF400482	400 x 482	182	132	32	
FPDBF/AF450525	450 x 525	185	129	47	
FPDBF/AF500580	500 x 580	211	144	47	
FPDBF/AF560685	560 x 685	180	125	47	
FPDBF/AF630685	630 x 685	205	145	50	
FPDBF/AF630720	630 x 720	205	145	50	
FPDBF/AF710800	710 x 800	185	110	56	
FPDBF/AF800905	800 x 905	185	110	56	
FPDBF/AF9001005	900 x 1005	185	110	56	
FPDBF/AF10001100	1000 x 1100	185	110	56	

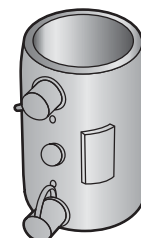

**Phụ kiện hàn điện - Electro Fusion Fittings**
**Nối thẳng - E/F Coupling**

Mã số Code	Kích cỡ Size	Đơn giá Unit Price (VND)
FPDEF/N20	20	
FPDEF/N25	25	
FPDEF/N32	32	
FPDEF/N40	40	
FPDEF/N50	50	
FPDEF/N63	63	
FPDEF/N75	75	
FPDEF/N90	90	
FPDEF/N110	110	
FPDEF/N125	125	
FPDEF/N160	160	
FPDEF/N180	180	
FPDEF/N200	200	
FPDEF/N250	250	
FPDEF/N315	315	
FPDEF/N400	400	
FPDEF/N500	500	

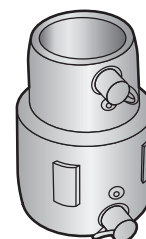

**Nối thu - E/F Reducer**

Mã số Code	Kích cỡ Size	Đơn giá Unit Price (VND)
FPDEF/NT4032	40 x 32	
FPDEF/NT5032	50 x 32	
FPDEF/NT5040	50 x 40	
FPDEF/NT6332	63 x 32	
FPDEF/NT6340	63 x 40	
FPDEF/NT6350	63 x 50	
FPDEF/NT7563	75 x 63	
FPDEF/NT9063	90 x 63	
FPDEF/NT9075	90 x 75	
FPDEF/NT11050	110 x 50	
FPDEF/NT11063	110 x 63	
FPDEF/NT11075	110 x 75	
FPDEF/NT11090	110 x 90	
FPDEF/NT12590	125 x 90	
FPDEF/NT16050	160 x 50	
FPDEF/NT16063	160 x 63	
FPDEF/NT16075	160 x 75	
FPDEF/NT16090	160 x 90	
FPDEF/NT160110	160 x 110	
FPDEF/NT20050	200 x 50	
FPDEF/NT20063	200 x 63	
FPDEF/NT20075	200 x 75	
FPDEF/NT20090	200 x 90	
FPDEF/NT200110	200 x 110	
FPDEF/NT200160	200 x 160	
FPDEF/NT25063	250 x 63	
FPDEF/NT25075	250 x 75	
FPDEF/NT25090	250 x 90	
FPDEF/NT250110	250 x 110	
FPDEF/NT250160	250 x 160	
FPDEF/NT250200	250 x 200	
FPDEF/NT315200	315 x 200	
FPDEF/NT315250	315 x 250	
FPDEF/NT400315	400 x 315	

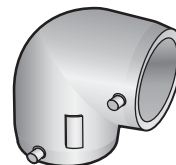

**Nối góc 90° - E/F 90° Elbow**

Mã số Code	Kích cỡ Size	Đơn giá Unit Price (VND)
FPDEF/G25	25	
FPDEF/G32	32	
FPDEF/G40	40	
FPDEF/G50	50	
FPDEF/G63	63	
FPDEF/G75	75	
FPDEF/G90	90	
FPDEF/G110	110	
FPDEF/G125	125	
FPDEF/G160	160	
FPDEF/G180	180	
FPDEF/G200	200	
FPDEF/G250	250	
FPDEF/G315	315	
FPDEF/G400	400	

**Nối góc 45° - E/F 45° Elbow**

Mã số Code	Kích cỡ Size	Đơn giá Unit Price (VND)
FPDEF/GH32	32	
FPDEF/GH40	40	
FPDEF/GH50	50	
FPDEF/GH63	63	
FPDEF/GH75	75	
FPDEF/GH90	90	
FPDEF/GH110	110	
FPDEF/GH125	125	
FPDEF/GH160	160	
FPDEF/GH180	180	
FPDEF/GH200	200	
FPDEF/GH250	250	
FPDEF/GH315	315	
FPDEF/GH400	400	

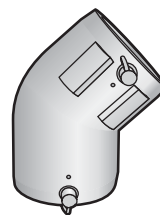

**Tê - E/F Tee**

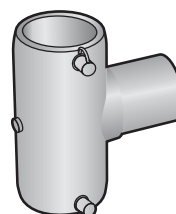
Mã số Code	Kích cỡ Size	Đơn giá Unit Price (VND)
FPDEF/T20	20	
FPDEF/T32	32	
FPDEF/T40	40	
FPDEF/T50	50	
FPDEF/T63	63	
FPDEF/T75	75	
FPDEF/T90	90	
FPDEF/T110	110	
FPDEF/T125	125	
FPDEF/T160	160	
FPDEF/T180	180	
FPDEF/T200	200	
FPDEF/T250	250	
FPDEF/T315	315	
FPDEF/T400	400	

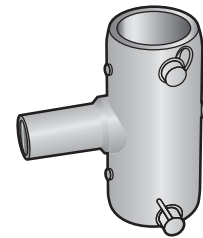

**Tê thu - E/F Reducing Tee**

Mã số Code	Kích cỡ Size	Đơn giá Unit Price (VND)
FPDEF/TT3220	32 x 20	
FPDEF/TT3225	32 x 25	
FPDEF/TT4020	40 x 20	
FPDEF/TT4025	40 x 25	
FPDEF/TT4032	40 x 32	
FPDEF/TT5020	50 x 20	
FPDEF/TT5025	50 x 25	
FPDEF/TT5032	50 x 32	
FPDEF/TT5040	50 x 40	
FPDEF/TT6320	63 x 20	
FPDEF/TT6325	63 x 25	
FPDEF/TT6332	63 x 32	
FPDEF/TT6340	63 x 40	
FPDEF/TT6350	63 x 50	
FPDEF/TT9040	90 x 40	
FPDEF/TT9050	90 x 50	
FPDEF/TT9063	90 x 63	
FPDEF/TT9075	90 x 75	
FPDEF/TT11050	110 x 50	
FPDEF/TT11063	110 x 63	
FPDEF/TT11075	110 x 75	
FPDEF/TT11090	110 x 90	
FPDEF/TT12563	125 x 63	
FPDEF/TT12575	125 x 75	
FPDEF/TT12590	125 x 90	
FPDEF/TT125110	125 x 110	
FPDEF/TT16050	160 x 50	
FPDEF/TT16063	160 x 63	
FPDEF/TT16075	160 x 75	
FPDEF/TT16090	160 x 90	
FPDEF/TT160110	160 x 110	
FPDEF/TT20050	200 x 50	
FPDEF/TT20063	200 x 63	
FPDEF/TT20075	200 x 75	
FPDEF/TT20090	200 x 90	
FPDEF/TT200110	200 x 110	
FPDEF/TT200160	200 x 160	
FPDEF/TT25050	250 x 50	
FPDEF/TT25063	250 x 63	
FPDEF/TT25075	250 x 75	
FPDEF/TT25090	250 x 90	
FPDEF/TT250110	250 x 110	
FPDEF/TT250160	250 x 160	
FPDEF/TT250200	250 x 200	
FPDEF/TT31590	315 x 90	
FPDEF/TT315110	315 x 110	
FPDEF/TT315160	315 x 160	
FPDEF/TT315200	315 x 200	
FPDEF/TT315250	315 x 250	
FPDEF/TT400110	400 x 110	
FPDEF/TT400160	400 x 160	
FPDEF/TT400200	400 x 200	
FPDEF/TT400250	400 x 250	
FPDEF/TT400315	400 x 315	



**Bích chặn - E/F Flange (Steel Tray)**

Mã số Code	Kích cỡ Size	Đơn giá Unit Price (VND)
FPVEF/SB110	110	
FPVEF/SB160	160	
FPVEF/SB200	200	
FPVEF/SB250	250	
FPVEF/SB315	315	
FPVEF/SB400	400	

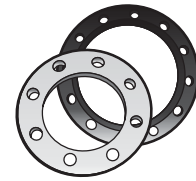

**Đai kẹp thẳng - E/F Straight Saddle**

Mã số Code	Kích cỡ Size	Đơn giá Unit Price (VND)
FPVEF/STS9063	90 x 63	
FPVEF/STS11063	110 x 63	
FPVEF/STS12563	125 x 63	
FPVEF/STS16063	160 x 63	
FPVEF/STS20063	200 x 63	
FPVEF/STS20090	200 x 90	
FPVEF/STS25090	250 x 90	
FPVEF/STS315110	315 x 110	
FPVEF/STS315160	315 x 160	

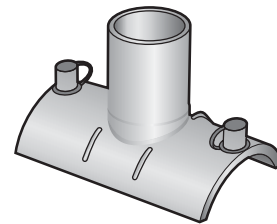

**Đai kẹp góc - E/F Tapping Saddle**

Mã số Code	Kích cỡ Size	Đơn giá Unit Price (VND)
FPVEF/STS6332	63 x 32	
FPVEF/STS9063	90 x 63	
FPVEF/STS11063	110 x 63	
FPVEF/STS12563	125 x 63	
FPVEF/STS16063	160 x 63	
FPVEF/STS20063	200 x 63	
FPVEF/STS20090	200 x 90	
FPVEF/STS25090	250 x 90	
FPVEF/STS315110	315 x 110	
FPVEF/STS315160	315 x 160	

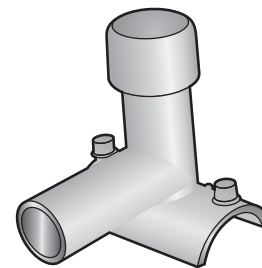

**Đai kẹp chặn - E/F Stop Saddle**

Mã số Code	Kích cỡ Size	Đơn giá Unit Price (VND)
FPVEF/SS90	90	
FPVEF/SS110	110	
FPVEF/SS125	125	
FPVEF/SS160	160	
FPVEF/SS200	200	
FPVEF/SS250	250	
FPVEF/SS315	315	

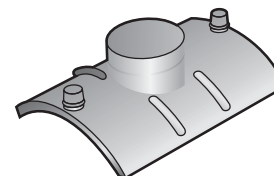

## SỬ DỤNG HÀN ĐIỆN NỐI ỐNG - *ELECTRO FUSION JOINT*

Các bước sử dụng máy hàn điện cực - *Step: use electro fusion welding machine*

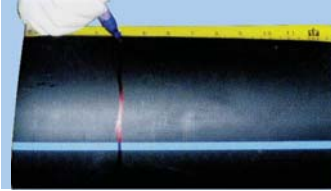

### 1. Vệ sinh và đánh dấu

Lau sạch mối nối, đánh dấu độ sâu mối hàn

1. *Clean and mark*

*Clean up the connection part, mark the inserting depth.*

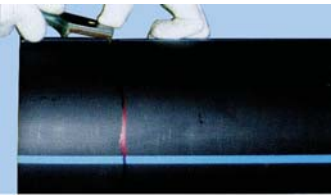

### 2. Cạo

Cạo và đánh bóng bề mặt mối nối

2. *Scrape*

*Scrape and polish the joint surface*



### 3. Sắp xếp các phụ kiện vào ống

3. *Align and restrain the fittings to the pipes*



### 4. Cắm các điện cực vào

Cắm các điện cực máy hàn vào các cực trên phụ kiện, phần nối sẽ bị nóng chảy. Ngắt điện khi thấy nhựa chảy qua lỗ quan sát

4. *Apply electric current*

*Apply the electric current to the fittings, the joining parts will be heated and melted, turn off the current when there is flowing in the observation hole.*



### 5. Làm nguội

Phải cố định mối nối khi làm nguội

5. *Cool*

*Cool without movement or pressure.*

**Ghi chú:** Khi nối ống, điện áp và thời gian hàn phải tuân thủ theo thông số kỹ thuật của nhà sản xuất máy hàn cung cấp.

*Note: While connecting, the heating voltage and time should comply with manufacture's technical stipulations of Electro Fusion Welding Machine.*